

**FUSION G7, TYPE 4 AND 12**



**INDUSTRY STANDARDS**

*Wall-mounting brackets required to maintain UL/CSA external mounting requirement.*

UL 508A Listed; Type 4, 12; File No. 61997  
 cUL Listed per CSA C22.2 No. 94; Type 4, 12; File No. 61997

NEMA/EEMAC Type 4, 12, 13  
 CSA File No. 42186: Type 4, 12  
 IEC 60529, IP66

**APPLICATION**

Innovative, metric-dimensioned wall-mount enclosure designed to house and protect electrical and electronic components in industrial environments. Provides traditional enclosure functionality with scalable internal component mounting capability using the optional internal mounting system and accessory components.

**SPECIFICATIONS**

- 1.2-mm (18 gauge), 1.5-mm (16 gauge) and 1.9-mm (14 gauge) steel
- Seamless foam-in-place gasket
- Reversible door with sealed hinges and hinge brackets
- Gland plate(s) for enclosure bottom
- Bonding provision on door; grounding studs (2) on body
- Full-height galvanized steel back panel included
- External formed 90-degree body flange channels away liquids
- Three-point latching on enclosures 1000-mm high and taller

- Door alignment device on doors with 3-point latching and 800 mm or wider
- Pre-cut gland plate opening(s) in enclosure bottom
- Quarter-turn latch(es) with 3-mm double-bit insert
- Corner-formed door
- Simple, easy-to-remove and install hinge pins with captivation clip
- High-torque threadless studs and fasteners on door
- Wide assortment of user-friendly internal accessories to increase internal mounting area capability and design flexibility
- Hardware kit includes grounding and sealing hardware
- Hinged on right side
- Installation instruction provided

**FINISH**

RAL 7035 textured, light-gray polyester powder paint inside and out. Panel is galvanized.

**ACCESSORIES**

- Gland Plate
- Full-Height Back Panel
- Half-Height Back Panel
- Half-Height Side Panel
- Side-Mount Accessory Rail
- Front and Back Vertical Accessory Mounting Rails
- Handles
- Aluminum Swing Panel
- FUSION G7 Door Stop Kit

**BULLETIN: A4G**

Standard Product

Catalog Number	AxBxC mm/in.	Body Thickness mm	Body Thickness Gauge	Door Thickness mm	Door Thickness Gauge	Latch Type	D x E mm/in.	G x H mm/in.	J mm/in.	P x Q mm/in.	S mm/in.
G300300225G	300 x 300 x 225 11.81 x 11.81 x 8.86	1.2	18	1.2	18	Quarter-turn	255 x 255 10.04 x 10.04	262 x 262 10.31 x 10.31	150 5.91	180 x 90 7.09 x 3.54	39 1.55
G300400200G	300 x 400 x 200 11.81 x 15.75 x 7.87	1.2	18	1.2	18	Quarter-turn	255 x 355 10.04 x 13.98	262 x 362 10.31 x 14.25	150 5.91	280 x 90 11.02 x 3.54	39 1.55
G400300150	400 x 300 x 150 15.75 x 11.81 x 5.91	1.2	18	1.2	18	Quarter-turn	355 x 255 13.98 x 10.04	362 x 262 14.25 x 10.31	200 7.87	— —	39 1.55
G400300225G	400 x 300 x 225 15.75 x 11.81 x 8.86	1.2	18	1.2	18	Quarter-turn	355 x 255 13.98 x 10.04	362 x 262 14.25 x 10.31	200 7.87	180 x 90 7.09 x 3.54	39 1.55
G400400225G	400 x 400 x 225 15.75 x 15.75 x 8.86	1.2	18	1.2	18	Quarter-turn	355 x 355 13.98 x 13.98	362 x 362 14.25 x 14.25	200 7.87	280 x 90 11.02 x 3.54	39 1.55
G400600225G	400 x 600 x 225 15.75 x 23.62 x 8.86	1.2	18	1.2	18	Quarter-turn	355 x 555 13.98 x 21.85	362 x 562 14.25 x 22.13	200 7.87	180 x 90 7.09 x 3.54	39 1.55
G500400225G	500 x 400 x 225 19.69 x 15.75 x 8.86	1.2	18	1.2	18	Quarter-turn	455 x 355 17.91 x 13.98	462 x 362 18.19 x 14.25	250 9.84	280 x 90 11.02 x 3.54	39 1.55
G500500225G	500 x 500 x 225 19.69 x 19.69 x 8.86	1.2	18	1.2	18	Quarter-turn	455 x 455 17.91 x 17.91	462 x 462 18.19 x 18.19	250 9.84	280 x 90 11.02 x 3.54	39 1.55
G500500300G	500 x 500 x 300 19.69 x 19.69 x 11.81	1.5	16	1.2	18	Quarter-turn	455 x 455 17.91 x 17.91	462 x 462 18.19 x 18.19	250 9.84	280 x 150 11.02 x 5.91	39 1.55
G600400225G	600 x 400 x 225 23.62 x 15.75 x 8.86	1.2	18	1.2	18	Quarter-turn	555 x 355 21.85 x 13.98	562 x 362 22.13 x 14.25	300 11.81	280 x 90 11.02 x 3.54	39 1.55
G600500200G	600 x 500 x 200 23.62 x 19.69 x 7.87	1.2	18	1.5	16	Quarter-turn	555 x 455 21.85 x 17.91	562 x 462 22.13 x 18.19	300 11.81	280 x 90 11.02 x 3.54	39 1.55
G600500300G	600 x 500 x 300 23.62 x 19.69 x 11.81	1.5	16	1.5	16	Quarter-turn	555 x 455 21.85 x 17.91	562 x 462 22.13 x 18.19	300 11.81	280 x 150 11.02 x 5.91	39 1.55
G600600225G	600 x 600 x 225 23.62 x 23.62 x 8.86	1.5	16	1.5	16	Quarter-turn	555 x 555 21.85 x 21.85	562 x 562 22.13 x 22.13	125 4.92	180 x 90 7.09 x 3.54	39 1.55
G600600325G	600 x 600 x 325 23.62 x 23.62 x 12.80	1.5	16	1.5	16	Quarter-turn	555 x 555 21.85 x 21.85	562 x 562 22.13 x 22.13	125 4.92	180 x 150 7.09 x 5.91	39 1.55
G600600400G	600 x 600 x 400 23.62 x 23.62 x 15.75	1.9	14	1.5	16	Quarter-turn	555 x 555 21.85 x 21.85	562 x 562 22.13 x 22.13	125 4.92	180 x 150 7.09 x 5.91	39 1.55
G600800300G	600 x 800 x 300 23.62 x 31.50 x 11.81	1.5	16	1.5	16	Quarter-turn	555 x 755 21.85 x 29.72	562 x 762 22.13 x 30.00	125 4.92	180 x 150 7.09 x 5.91	102 4.02
G700500250G	700 x 500 x 250 27.56 x 19.69 x 9.84	1.5	16	1.5	16	Quarter-turn	655 x 455 25.79 x 17.91	662 x 462 26.06 x 18.19	125 4.92	280 x 90 11.02 x 3.54	39 1.55
G800600225G	800 x 600 x 225 31.50 x 23.62 x 8.86	1.5	16	1.5	16	Quarter-turn	755 x 555 29.72 x 21.85	762 x 562 30.00 x 22.13	125 4.92	180 x 90 7.09 x 3.54	39 1.55
G800600325G	800 x 600 x 325 31.50 x 23.62 x 12.80	1.5	16	1.5	16	Quarter-turn	755 x 555 29.72 x 21.85	762 x 562 30.00 x 22.13	125 4.92	180 x 150 7.09 x 5.91	39 1.55
G800600425G	800 x 600 x 425 31.50 x 23.62 x 16.73	1.9	14	1.5	16	Quarter-turn	755 x 555 29.72 x 21.85	762 x 562 30.00 x 22.13	125 4.92	180 x 150 7.09 x 5.91	39 1.55
G800800225G	800 x 800 x 225 31.50 x 31.50 x 8.86	1.5	16	1.9	14	Quarter-turn	755 x 755 29.72 x 29.72	762 x 762 30.00 x 30.00	125 4.92	280 x 90 11.02 x 3.54	39 1.55
G800800300G	800 x 800 x 300 31.50 x 31.50 x 11.81	1.9	14	1.9	14	Quarter-turn	755 x 755 29.72 x 29.72	762 x 762 30.00 x 30.00	125 4.92	180 x 150 7.09 x 5.91	102 4.02
G1000600250G	1000 x 600 x 250 39.37 x 23.62 x 9.84	1.9	14	1.9	14	3-pt. Quarter-turn	955 x 555 37.60 x 21.85	962 x 562 37.87 x 22.13	500 19.68	180 x 90 7.09 x 3.54	39 1.55
G1000800300G	1000 x 800 x 300 39.37 x 31.50 x 11.81	1.9	14	1.9	14	3-pt. Quarter-turn	955 x 755 37.60 x 29.72	962 x 762 37.87 x 30.00	500 19.68	180 x 150 7.09 x 5.91	102 4.02
G1000800400G	1000 x 800 x 400 39.37 x 31.50 x 15.75	1.9	14	1.9	14	3-pt. Quarter-turn	955 x 755 37.60 x 29.72	962 x 762 37.87 x 30.00	500 19.68	180 x 150 7.09 x 5.91	102 4.02
G1200800300G	1200 x 800 x 300 47.24 x 31.50 x 11.81	1.9	14	1.9	14	3-pt. Quarter-turn	1155 x 755 45.47 x 29.72	1162 x 762 45.75 x 30.00	600 23.62	180 x 150 7.09 x 5.91	102 4.02
G1200800400G	1200 x 800 x 400 47.24 x 31.50 x 15.75	1.9	14	1.9	14	3-pt. Quarter-turn	1155 x 755 45.47 x 29.72	1162 x 762 45.75 x 30.00	600 23.62	180 x 150 7.09 x 5.91	102 4.02
G1200900325G	1200 x 900 x 325 47.24 x 35.43 x 12.80	1.9	14	1.9	14	3-pt. Quarter-turn	1155 x 855 45.47 x 33.66	1162 x 862 45.75 x 33.94	600 23.62	280 x 150 11.02 x 5.91	102 4.02
G1500900325G	1500 x 900 x 325 59.06 x 35.43 x 12.80	1.9	14	1.9	14	3-pt. Quarter-turn	1455 x 855 57.28 x 33.66	1462 x 862 57.57 x 33.94	750 29.53	280 x 150 11.02 x 5.91	102 4.02
G1500900425G	1500 x 900 x 425 59.06 x 35.43 x 16.73	1.9	14	1.9	14	3-pt. Quarter-turn	1455 x 855 57.28 x 33.66	1462 x 862 57.57 x 33.94	750 29.53	280 x 150 11.02 x 5.91	102 4.02

G400300150 does not have a gland plate.

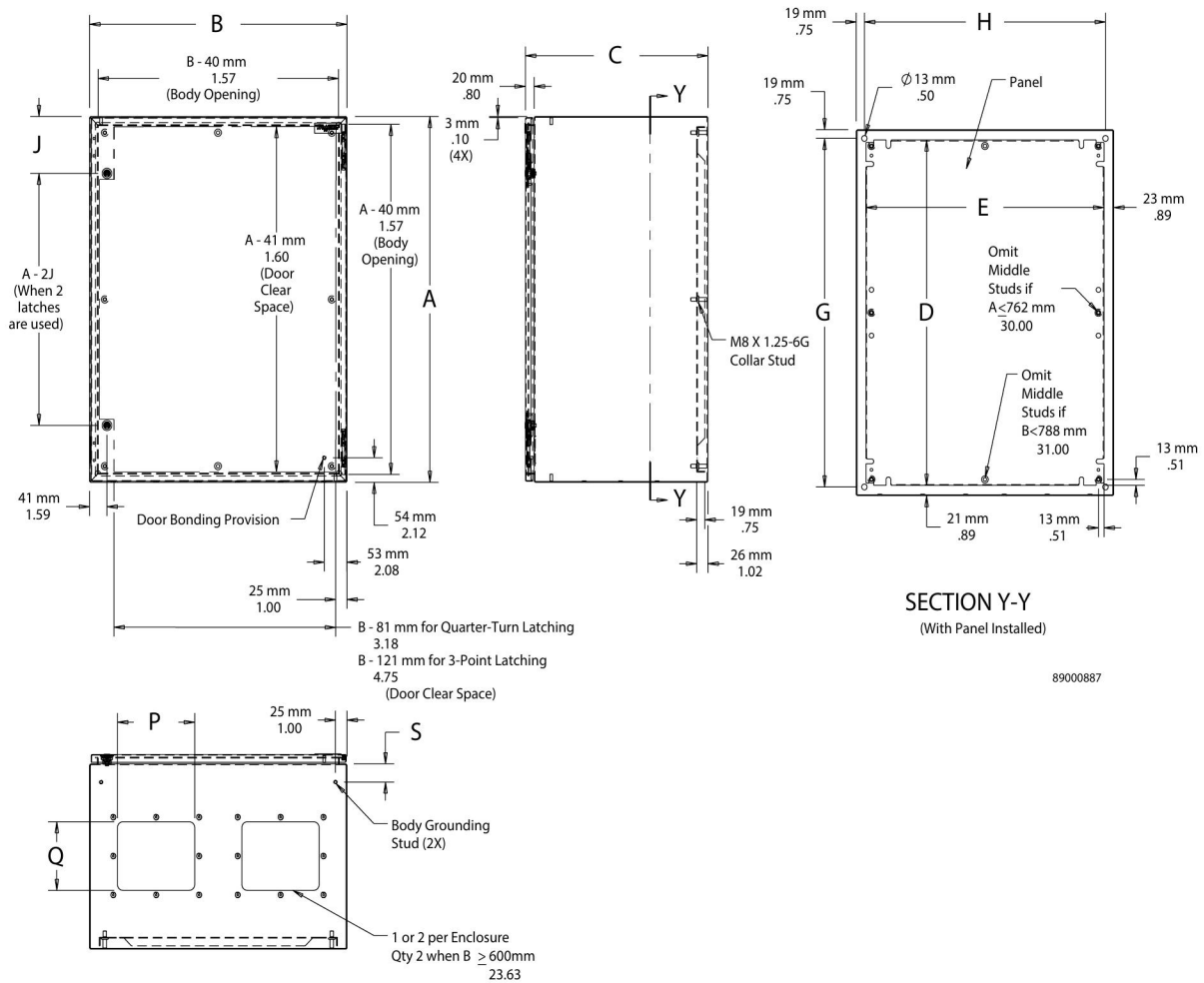

Accessory Selection Matrix

FUSION G7	Full Back Panel	Half Back Panel	Full Side Panel	Half Side Panel	Side-Mount Accessory Rail	Horizontal Separator	100-mm Plinth Base	Aluminum Swing Panel	Front and Back Vertical Accessory Mounting Rails	Top/Bottom Mounting Brackets
G300300225G	G300P300	G300P300H	G300SMP225	G300SMP225H	G50SMR225	GHS300225	-	-	GAMR300	GTBMTBKT300
G300400200G	G400P300	G300P400H	G300SMP200	G300SMP200H	G50SMR200	GHS400200	-	-	GAMR300	GTBMTBKT400
G400300150	G400P300	G400P300H	G400SMP150	G400SMP150H	G50SMR150	-	-	-	GAMR400	GTBMTBKT300
G400300225G	G400P300	G400P300H	G400SMP225	G400SMP225H	G50SMR225	GHS300225	-	GSP400300A	GAMR400	GTBMTBKT300
G400400225G	G400P400	G400P400H	G400SMP225	G400SMP225H	G50SMR225	GHS400225	-	-	GAMR400	GTBMTBKT400
G400600225G	G600P400	G400P600H	G400SMP225	G400SMP225H	G50SMR225	GHS600225	-	-	GAMR400	GTBMTBKT600
G500400225G	G500P400	G500P400H	G500SMP225	G500SMP225H	G50SMR225	GHS400225	-	GSP500400A	GAMR500	GTBMTBKT400
G500500225G	G500P500	G500P500H	G500SMP225	G500SMP225H	G50SMR225	GHS500225	-	GSP500500A	GAMR500	GTBMTBKT500
G500500300G	G500P500	G500P500H	G500SMP300	G500SMP300H	G50SMR300	GHS500300	-	GSP500500A	GAMR500	GTBMTBKT500
G600400225G	G600P400	G600P400H	G600SMP225	G600SMP225H	G50SMR225	GHS400225	-	-	GAMR600	GTBMTBKT400
G600500200G	G600P500	G600P500H	G600SMP200	G600SMP200H	G50SMR200	GHS500200	-	GSP600500A	GAMR600	GTBMTBKT500
G600500300G	G600P500	G600P500H	G600SMP300	G600SMP300H	G50SMR300	GHS500300	-	GSP600500A	GAMR600	GTBMTBKT500
G600600225G	G600P600	G600P600H	G600SMP225	G600SMP225H	G50SMR225	GHS600225	-	GSP600600A	GAMR600	GTBMTBKT600
G600600325G	G600P600	G600P600H	G600SMP325	G600SMP325H	G50SMR325	GHS600325	-	GSP600600A	GAMR600	GTBMTBKT600
G600600400G	G600P600	G600P600H	G600SMP400	G600SMP400H	G50SMR400	GHS600400	-	GSP600600A	GAMR600	GTBMTBKT600
G600800300G	G800P600	G600P800H	G600SMP300	G600SMP300H	G50SMR300	GHS800300	GPB800300	-	GAMR600	GTBMTBKT800
G700500250G	G700P500	G700P500H	G700SMP250	G700SMP250H	G50SMR250	GHS500250	-	GSP700500A	GAMR700	GTBMTBKT500
G800600225G	G800P600	G800P600H	G800SMP225	G800SMP225H	G50SMR225	GHS600225	-	GSP800600A	GAMR800	GTBMTBKT600
G800600325G	G800P600	G800P600H	G800SMP325	G800SMP325H	G50SMR325	GHS600325	-	GSP800600A	GAMR800	GTBMTBKT600
G800600425G	G800P600	G800P600H	G800SMP425	G800SMP425H	G50SMR425	-	-	GSP800600A	GAMR800	GTBMTBKT600
G800800225G	G800P800	G800P800H	G800SMP225	G800SMP225H	G50SMR225	-	-	-	GAMR800	GTBMTBKT800
G800800300G	G800P800	G800P800H	G800SMP300	G800SMP300H	G50SMR300	GHS800300	GPB800300	-	GAMR800	GTBMTBKT800
G1000600250G	G1000P600	G1000P600H	G1000SMP250	G1000SMP250H	G50SMR250	GHS600250	-	GSP1000600A	GAMR1000	GTBMTBKT600
G1000800300G	G1000P800	G1000P800H	G1000SMP300	G1000SMP300H	G50SMR300	GHS800300	GPB800300	GSP1000800A	GAMR1000	GTBMTBKT800
G1000800400G	G1000P800	G1000P800H	G1000SMP400	G1000SMP400H	G50SMR400	GHS800400	GPB800400	GSP1000800A	GAMR1000	GTBMTBKT800
G1200800300G	G1200P800	G1200P800H	G1200SMP300	G1200SMP300H	G50SMR300	GHS800300	GPB800300	GSP1200800A	GAMR1200	GTBMTBKT800
G1200800400G	G1200P800	G1200P800H	G1200SMP400	G1200SMP400H	G50SMR400	GHS800400	GPB800400	GSP1200800A	GAMR1200	GTBMTBKT800
G1200900325G	G1200P900	G1200P900H	G1200SMP325	G1200SMP325H	G50SMR325	GHS900325	GPB900325	GSP1200900A	GAMR1200	GTBMTBKT900
G1500900325G	G1500P900	G1500P900H	G1500SMP325	G1500SMP325H	G50SMR325	GHS900325	GPB900325	GSP1500900A	GAMR1500	GTBMTBKT900
G1500900425G	G1500P900	G1500P900H	G1500SMP425	G1500SMP425H	G50SMR425	GHS900425	GPB900425	GSP1500900A	GAMR1500	GTBMTBKT900



**GLAND PLATE**



Constructed of 1.5-mm thick (16 gauge) steel and designed for use with FUSION G7 enclosures. Provides a removable cable egress and entry plate while maintaining IP/UL/CSA integrity of the enclosure. RAL 7035 textured, light-gray polyester powder paint finish. Foam-in-place gasket, fasteners and instructions provided. Maintains IP66/UL/CSA Type 4 and 12 when properly installed on a Hoffman enclosure.

**BULLETIN: A4GY**

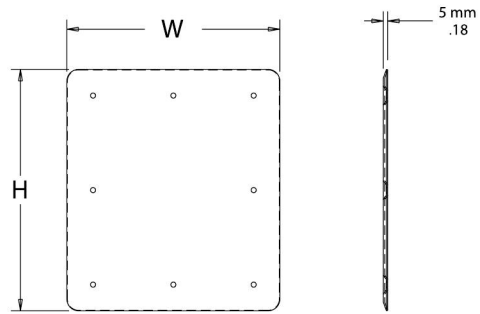

89000888

Catalog Number	Cutout Size (mm)	Cutout Size (in.)	W x H (mm)	W x H (in.)
GGP90180	90 x 180	3.54 x 7.09	165 x 255	6.50 x 10.04
GGP90280	90 x 280	3.54 x 11.02	165 x 355	6.50 x 13.98
GGP150180	150 x 180	5.91 x 7.09	225 x 255	8.86 x 10.04
GGP150280	150 x 280	5.91 x 11.02	225 x 355	8.86 x 13.98

**FRONT AND BACK VERTICAL ACCESSORY MOUNTING RAILS**



Constructed of galvanized steel. Front rail is 2.0-mm thick (14 gauge) and back rail is 1.5-mm thick (16 gauge). Package includes two front and two back rails and mounting screws.

*Required for side-mount and adjustable-depth accessory installation.*

**BULLETIN: A4GY**

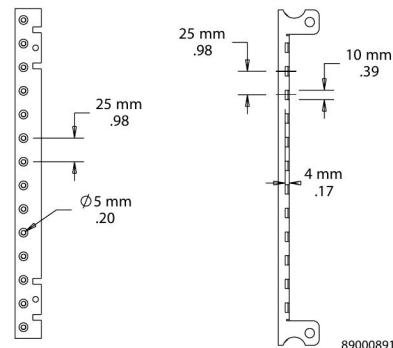

Front Rail

Back Rail

89000891

Catalog Number	Fits A (mm)	Fits A (in.)
GAMR300	300	11.81
GAMR400	400	15.75
GAMR500	500	19.68
GAMR600	600	23.62
GAMR700	700	27.56
GAMR800	800	31.50
GAMR1000	1000	39.37
GAMR1200	1200	47.24
GAMR1500	1500	59.05

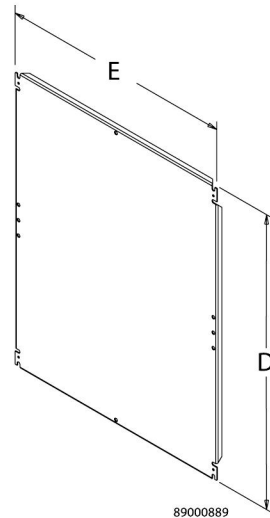
**FULL-HEIGHT BACK PANEL**

Galvanized steel full-height panels. See table for thickness.  
**M8 panel mounting nuts provided with 50-mm front-to-back side-mount accessory rails and side-mount accessory rail brackets.**

**BULLETIN: A4GY**

Catalog Number	D x E (mm)	D x E (in.)	Thickness (mm)	Thickness (Gauge)	Fits A x B (mm)	Fits A x B (in.)
G300P300	255 x 255	10.04 x 10.04	1.5	16	300 x 300	11.81 x 11.81
G400P300	355 x 255	13.98 x 10.04	1.5	16	400 x 300 or 300 x 400	15.75 x 11.81 or 11.81 x 15.75
G400P400	355 x 355	13.98 x 13.98	1.5	16	400 x 400	15.75 x 15.75
G500P400	455 x 355	17.91 x 13.98	1.5	16	500 x 400	19.68 x 15.75
G600P400	555 x 355	21.85 x 13.98	1.5	16	600 x 400 or 400 x 600	23.62 x 15.75 or 15.75 x 23.62
G500P500	455 x 455	17.91 x 17.91	1.5	16	500 x 500	19.68 x 19.68
G600P500	555 x 455	21.85 x 17.91	1.5	16	600 x 500	23.62 x 19.68
G700P500	655 x 455	25.79 x 17.91	2.0	14	700 x 500	27.56 x 19.68
G600P600	555 x 555	21.85 x 21.85	2.0	14	600 x 600	23.62 x 23.62
G800P600	755 x 555	29.72 x 21.85	2.0	14	800 x 600 or 600 x 800	31.50 x 23.62 or 23.62 x 31.50
G1000P600	955 x 555	37.60 x 21.85	2.5	12	1000 x 600	39.37 x 23.62
G800P800	755 x 755	29.72 x 29.72	2.5	12	800 x 800	31.50 x 31.50
G1000P800	955 x 755	37.60 x 29.72	2.5	12	1000 x 800	39.37 x 31.50
G1200P800	1155 x 755	45.47 x 29.72	2.5	12	1200 x 800	47.24 x 31.50
G1200P900	1155 x 855	45.47 x 33.66	2.5	12	1200 x 900	47.24 x 35.43
G1500P900	1455 x 855	57.28 x 33.66	2.5	12	1500 x 900	59.05 x 35.43

### HALF-HEIGHT BACK PANEL

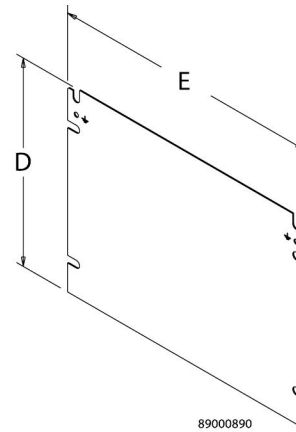
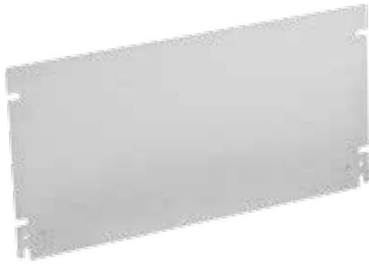

Galvanized steel half-height back panels. See table for thickness. *M8 panel mounting nuts provided with 50-mm front-to-back side-mount accessory rails and side-mount accessory rail brackets.*

BULLETIN: A4GY

89000890

Catalog Number	D x E (mm)	D x E (in.)	Thickness (mm)	Thickness (Gauge)	Fits A x B (mm)	Fits A x B (in.)
G300P300H	120 x 255	4.72 x 10.04	1.5	16	300 x 300	11.81 x 11.81
G300P400H	120 x 355	4.72 x 13.98	1.5	16	300 x 400	11.81 x 15.75
G400P300H	170 x 255	6.69 x 10.01	1.5	16	400 x 300	15.75 x 11.81
G400P400H	170 x 355	6.69 x 13.98	1.5	16	400 x 400	15.75 x 15.75
G400P600H	170 x 555	6.69 x 21.85	1.5	16	400 x 600	15.75 x 23.62
G500P400H	220 x 355	8.66 x 13.98	1.5	16	500 x 400	19.68 x 15.75
G500P500H	220 x 455	8.66 x 17.91	1.5	16	500 x 500	19.68 x 19.68
G600P400H	270 x 355	10.63 x 13.98	1.5	16	600 x 400	23.62 x 15.75
G600P500H	270 x 455	10.63 x 17.91	1.5	16	600 x 500	23.62 x 19.68
G600P600H	270 x 555	10.63 x 21.85	1.5	16	600 x 600	23.62 x 23.62
G600P800H	270 x 755	10.63 x 29.72	1.5	16	600 x 800	23.62 x 32.50
G700P500H	320 x 455	12.60 x 17.91	1.5	16	700 x 500	27.56 x 19.68
G800P600H	370 x 555	14.57 x 21.85	1.5	16	800 x 600	31.50 x 23.62
G800P800H	370 x 755	14.57 x 29.72	1.5	16	800 x 800	32.50 x 32.50
G1000P600H	470 x 555	18.50 x 21.85	1.5	16	1000 x 600	39.37 x 23.62
G1000P800H	470 x 755	18.50 x 29.72	2.0	14	1000 x 800	39.37 x 31.50
G1200P800H	570 x 755	22.44 x 29.72	2.0	14	1200 x 800	47.24 x 31.50
G1200P900H	570 x 855	22.44 x 33.66	2.0	14	1200 x 900	47.24 x 35.43
G1500P900H	720 x 855	28.35 x 33.66	2.0	14	1500 x 900	59.05 x 35.43

**FULL-HEIGHT SIDE PANEL**

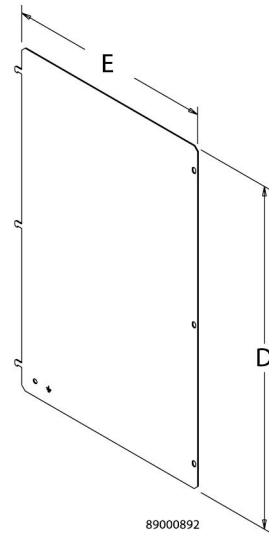

Galvanized steel full-height side panels. Panel mounting hardware is furnished with the panel. See table for thickness.

BULLETIN: A4GY

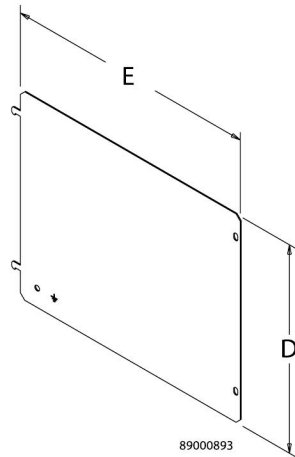

Catalog Number	D x E (mm)	D x E (in.)	Thickness (mm)	Thickness (Gauge)	Fits A x C (mm)	Fits A x C (in.)
G300SMP200	255 x 142	10.04 x 5.59	1.5	16	300 x 200	11.71 x 7.87
G300SMP225	255 x 167	10.01 x 6.57	1.5	16	300 x 255	11.71 x 10.04
G400SMP150	355 x 92	13.98 x 3.62	1.5	16	400 x 150	15.75 x 5.91
G400SMP225	355 x 167	13.98 x 6.57	1.5	16	400 x 225	15.75 x 10.04
G500SMP225	455 x 167	17.91 x 6.57	1.5	16	500 x 255	19.68 x 10.04
G500SMP300	455 x 242	17.91 x 9.53	1.5	16	500 x 300	19.68 x 11.71
G600SMP200	555 x 142	21.85 x 5.59	1.5	16	600 x 200	23.62 x 7.87
G600SMP225	555 x 167	21.85 x 6.57	1.5	16	600 x 225	23.62 x 10.04
G600SMP300	555 x 242	21.85 x 9.53	1.5	16	600 x 300	23.62 x 11.71
G600SMP325	555 x 267	21.85 x 10.51	1.5	16	600 x 325	23.62 x 12.80
G600SMP400	555 x 342	21.85 x 13.46	1.5	16	600 x 400	23.62 x 15.75
G700SMP250	655 x 192	25.79 x 7.56	1.5	16	700 x 250	27.56 x 9.84
G800SMP225	755 x 167	29.72 x 6.57	1.5	16	800 x 225	31.50 x 10.04
G800SMP300	755 x 242	29.72 x 9.53	1.5	16	800 x 300	31.50 x 11.71
G800SMP325	755 x 267	29.72 x 10.51	1.5	16	800 x 325	31.50 x 12.80
G800SMP425	755 x 367	29.72 x 14.45	1.5	16	800 x 425	31.50 x 16.73
G1000SMP250	955 x 192	37.60 x 7.56	1.5	16	1000 x 250	39.37 x 9.87
G1000SMP300	955 x 242	37.60 x 9.53	1.5	16	1000 x 300	39.37 x 11.71
G1000SMP400	955 x 342	37.60 x 13.46	1.5	16	1000 x 400	39.37 x 15.75
G1200SMP300	1155 x 242	45.47 x 9.53	1.5	16	1200 x 300	47.24 x 11.71
G1200SMP325	1155 x 267	45.47 x 10.51	1.5	16	1200 x 325	47.24 x 12.80
G1200SMP400	1155 x 342	45.47 x 13.46	1.5	16	1200 x 400	47.24 x 15.75
G1500SMP325	1455 x 267	57.28 x 10.51	1.5	16	1500 x 325	59.05 x 12.80
G1500SMP425	1455 x 367	57.28 x 14.45	1.5	16	1500 x 425	59.05 x 16.73

### HALF-HEIGHT SIDE PANEL



Galvanized steel half-height side panels are 1.5-mm thick (16 gauge). Panel mounting hardware is furnished with the panel.

**BULLETIN: A4GY**

Catalog Number	D x E (mm)	D x E (in.)	Fits A x C (mm)	Fits A x C (in.)
G300SMP200H	120 x 142	4.72 x 5.59	300 x 200	11.81 x 7.87
G300SMP225H	120 x 167	4.72 x 6.57	300 x 225	11.81 x 8.86
G400SMP150H	170 x 92	6.69 x 3.62	400 x 150	15.75 x 5.91
G400SMP225H	170 x 167	6.69 x 6.57	400 x 225	15.75 x 8.86
G500SMP225H	220 x 167	8.66 x 6.57	500 x 225	19.68 x 8.86
G500SMP300H	220 x 242	8.66 x 9.53	500 x 300	19.68 x 11.81
G600SMP200H	270 x 142	10.63 x 5.59	600 x 200	23.62 x 7.87
G600SMP225H	270 x 167	10.63 x 6.57	600 x 225	23.62 x 8.86
G600SMP300H	270 x 242	10.63 x 9.53	600 x 300	23.62 x 11.81
G600SMP325H	270 x 267	10.63 x 10.51	300 x 325	11.81 x 12.76
G600SMP400H	270 x 342	10.63 x 13.46	600 x 400	23.62 x 15.75
G700SMP250H	320 x 192	12.60 x 7.56	700 x 250	27.56 x 9.84
G800SMP225H	370 x 167	14.57 x 6.57	800 x 225	31.50 x 8.86
G800SMP300H	370 x 242	14.57 x 9.53	800 x 300	31.50 x 11.81
G800SMP325H	370 x 267	14.57 x 10.51	800 x 325	31.50 x 12.76
G800SMP425H	370 x 367	14.57 x 14.45	800 x 425	31.50 x 16.73
G1000SMP250H	470 x 192	18.50 x 7.56	1000 x 250	39.37 x 9.84
G1000SMP300H	470 x 242	18.50 x 9.53	1000 x 300	39.37 x 11.81
G1000SMP400H	470 x 342	18.50 x 13.46	1000 x 400	39.37 x 15.75
G1200SMP300H	570 x 242	22.44 x 9.53	1200 x 300	47.24 x 11.81
G1200SMP325H	570 x 267	22.44 x 10.51	1200 x 325	47.24 x 12.76
G1200SMP400H	570 x 342	22.44 x 13.46	1200 x 400	47.24 x 15.75
G1500SMP325H	720 x 267	28.35 x 10.51	1500 x 325	59.05 x 12.80
G1500SMP425H	720 x 367	28.35 x 14.45	1500 x 425	59.05 x 16.73

### SIDE-MOUNT ACCESSORY RAIL

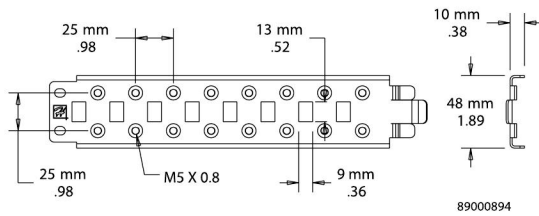

Easy-to-install side (front-to-back) mounting rails provide side and depth mounting capability using minimal tools. Rails are 1.5-mm thick (16 gauge) galvanized steel. Qty. 4 per package. Includes panel-mount brackets, nuts and screws.

**BULLETIN: A4GY**

Catalog Number	Fits Depth (mm)	Fits Depth (in.)
G50SMR150	150	5.91
G50SMR200	200	7.87
G50SMR225	225	8.86
G50SMR250	250	9.84
G50SMR300	300	11.81
G50SMR325	325	12.80
G50SMR400	400	15.75
G50SMR425	425	16.73



**HORIZONTAL SEPARATOR**

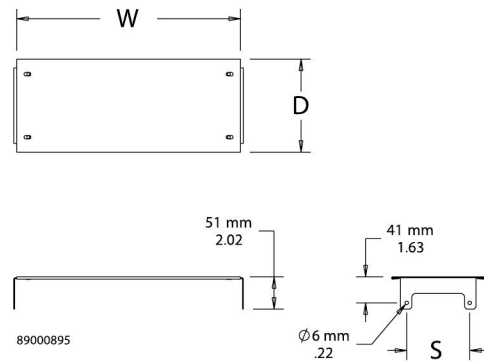

Horizontal Separator mounts onto side-mount accessory rails to divide the FUSION G7 into separate compartments. Galvanized 1.5-mm thick (16 gauge) steel. Mounting hardware provided.

**BULLETIN: A4GY**

Catalog Number	Fits B x C (mm)	Fits B x C (in.)	W x D (mm)	W x D (in.)	S (mm)	S (in.)
GHS300225	300 x 225	11.81 x 8.86	255 x 148	10.04 x 5.83	100	3.94
GHS400200	400 x 200	15.75 x 7.87	355 x 123	13.98 x 4.84	75	2.95
GHS400225	400 x 225	15.75 x 8.86	355 x 148	13.98 x 5.83	100	3.94
GHS500200	500 x 200	19.68 x 7.87	455 x 123	17.91 x 4.84	75	2.95
GHS500225	500 x 225	19.68 x 8.86	455 x 148	17.91 x 5.83	100	3.94
GHS500250	500 x 250	19.68 x 9.84	455 x 173	17.91 x 6.81	125	4.92
GHS500300	500 x 300	19.68 x 11.81	455 x 223	17.91 x 8.87	175	6.89
GHS600225	600 x 225	23.62 x 8.86	555 x 148	21.85 x 5.83	100	3.94
GHS600250	600 x 250	23.62 x 9.84	555 x 173	21.85 x 6.81	125	4.92
GHS600325	600 x 325	23.62 x 12.80	555 x 248	21.85 x 9.76	200	7.78
GHS600400	600 x 400	23.62 x 15.75	555 x 323	21.85 x 12.72	275	10.83
GHS800300	800 x 300	32.50 x 11.81	755 x 223	29.72 x 8.78	175	6.89
GHS800400	800 x 400	32.50 x 15.75	755 x 323	29.72 x 12.72	275	10.83
GHS900325	900 x 325	35.43 x 12.50	855 x 248	33.66 x 9.76	200	7.87
GHS900425	900 x 425	35.43 x 16.73	855 x 348	33.66 x 13.70	300	11.81

**PADLOCK INSERTS**

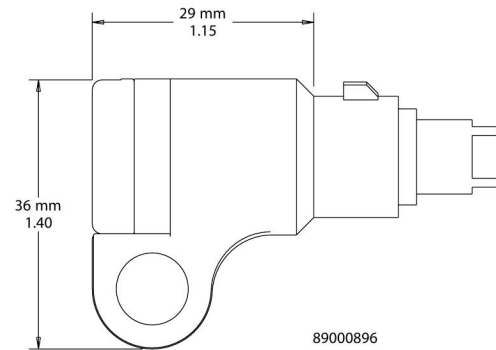

Padlock Inserts fit into standard quarter-turn latches in both FUSION G7 and CONCEPT enclosures. They are made of black composite material (PBT) with zinc insert and replace the standard 3-mm double-bit insert when padlocking security is required. Available with 3-mm double bit or slotted screwdriver tool to open. Accommodate up to 5/16-in. diameter padlock shank.

**BULLETIN: A4GY**

Catalog Number	Description
GPDLCK3MM	3-mm double-bit padlock insert
GPDLCKSLOT	Slotted screwdriver padlock insert

**PADLOCK HANDLES**

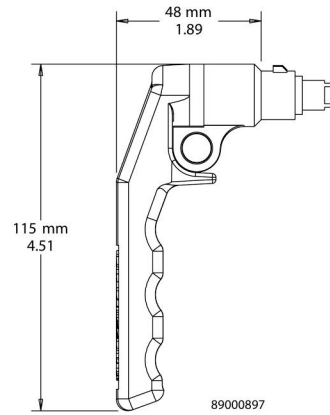

This black, composite, padlocking handle with zinc insert can replace the standard quarter-turn, 3-mm double bit insert on FUSION G7 and CONCEPT wall-mount enclosures. It accommodates up to a 5/16-in. diameter padlock shank and can be converted from clockwise to counterclockwise opening. Maintains IP66 and UL/CSA Type 12, 4 and 4X when properly installed in a Hoffman CONCEPT and FUSION G7 enclosure.

**BULLETIN: A4GY**

Catalog Number	Description
GPDLOCKHDL	Padlocking Handle

**HINGE PIN KITS**



Easy-to-remove and replace hinge pins facilitate door removal or reversing. Available in plated or stainless steel.

**BULLETIN: A4GY, VM3**

Catalog Number	Description	Pkg. Qty.
GHPINSS	Stainless steel	2
GHPINMS	Plated steel	2

**DIN RAIL MOUNTING ADAPTER**



Allows quick and simple installation of TS35 x 7.5 DIN (DIN3) rail. Black composite (PBT) material. DIN rail not included.

**BULLETIN: A4GY**

Catalog Number	Pkg. Qty.
GDINRAILBKT	10

100-MM PLINTH BASE



Install 100-mm Plinth Base under FUSION G7 enclosure to provide space for cables to enter from below. Constructed of 1.5-mm thick (16 gauge) steel sides and 2.5-mm thick (12 gauge) corners with textured RAL 9005 black finish. Mounting hardware included with base.

BULLETIN: A4GY

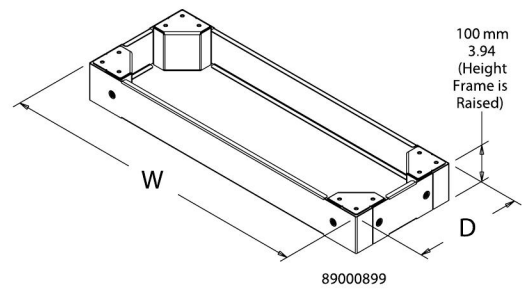

Catalog Number	Fits B x C (mm)	Fits B x C (in.)	W x D (mm)	W x D (in.)
GPB800300	800 x 300	31.50 x 11.81	800 x 279	31.50 x 10.98
GPB800400	800 x 400	31.50 x 15.75	800 x 379	31.50 x 14.92
GPB900325	900 x 325	35.43 x 12.80	900 x 304	35.43 x 11.97
GPB900425	900 x 425	35.43 x 16.73	900 x 404	35.43 x 15.91

ALUMINUM SWING PANEL



2.5-mm (.100-in.) thick Aluminum Swing Panel provides a convenient way to install controls and instruments near the front of the FUSION G7 enclosure while providing access and security. Mounting hardware and 3-mm double-bit key included with panel.

BULLETIN: A4GY

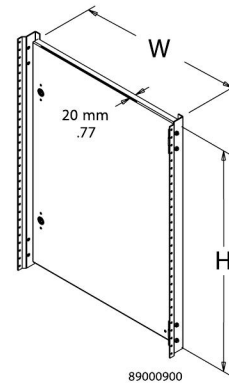

Catalog Number	Fits A x B (mm)	Fits A x B (in.)	H x W (mm)	H x W (in.)
GSP400300A	400 x 300	15.75 x 11.81	315 x 233	12.40 x 9.16
GSP500400A	500 x 400	19.68 x 15.75	415 x 333	16.34 x 13.11
GSP500500A	500 x 500	19.68 x 19.68	415 x 433	16.34 x 17.05
GSP600500A	600 x 500	23.62 x 19.68	515 x 433	20.27 x 17.05
GSP600600A	600 x 600	23.62 x 23.62	515 x 533	20.27 x 20.98
GSP700500A	700 x 500	27.56 x 19.68	615 x 433	24.21 x 17.05
GSP800600A	800 x 600	32.50 x 23.62	715 x 533	28.15 x 20.98
GSP1000600A	1000 x 600	39.37 x 23.62	915 x 533	36.02 x 20.98
GSP1000800A	1000 x 800	39.37 x 31.50	915 x 733	36.02 x 28.86
GSP1200800A	1200 x 800	47.24 x 31.50	1115 x 733	28.24 x 28.86
GSP1200900A	1200 x 900	47.24 x 35.43	1115 x 833	28.24 x 32.80
GSP1500900A	1500 x 900	59.05 x 35.43	1415 x 833	55.71 x 32.80

DOUBLE-BIT KEYS



Black non-metallic 3-mm double-bit keys. Package of two.

BULLETIN: A4GY

Catalog Number	Description	Pkg. Qty.
GKEY3MMDB	3-mm black, non-metallic	2

**SCREW PACKAGE**



5-mm screws for FUSION G7 internal accessories. Package of 20.

**BULLETIN: A4GY**

Catalog Number	Description	Pkg. Qty.
GSM5	5-mm screw M5 x 0.8 x 10	20

**PANEL MOUNTING BRACKETS**



Package includes four mounting brackets, four M8 nuts and eight 5-mm screws.

**BULLETIN: A4GY**

Catalog Number	Description
GSMRBKTS	Panel mounting brackets; fit side-mount accessory rails

**FULL-WIDTH TOP AND BOTTOM MOUNTING-BRACKET KITS WITH STUDS**

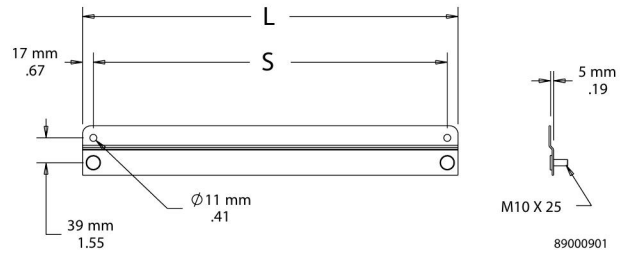
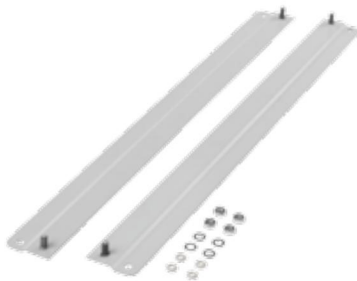

Use to mount FUSION G7 to a wall or another enclosure. Includes two 2.5-mm thick (12 gauge) steel external mounting brackets and mounting hardware. Finished with RAL 7035 textured light-gray polyester powder paint.

*Mounting brackets are required to maintain UL/CSA external mounting requirement.*

**BULLETIN: A4GY**

Catalog Number	Fits B (mm)	Fits B (in.)	L (mm)	L (in.)	S (mm)	S (in.)
GTBMTBKT300	300	11.81	296	11.65	262	10.31
GTBMTBKT400	400	15.75	396	15.59	362	14.25
GTBMTBKT500	500	19.68	496	19.53	462	18.19
GTBMTBKT600	600	23.62	596	23.46	562	22.12
GTBMTBKT800	800	31.50	796	31.34	762	30.00
GTBMTBKT900	900	35.43	896	35.62	862	33.93

**FUSION G7 DOOR STOP KIT**



Designed for use on FUSION G7 enclosures to secure the door in the open position. Door Stop Kit can be mounted at the top or bottom of the door opening, as well as left- or right-hinged. Door stop is stainless steel with plated and stainless steel mounting hardware. Maintains IP66 and UL/CSA Type 4 and 12 when properly installed in a Hoffman FUSION G7 enclosure.

**BULLETIN: A4GY**

Catalog Number	Description
GDSTOPK	FUSION G7 Door Stop Kit

**LOCK INSERTS**



Lock inserts can be substituted for the standard 3-mm double-bit latch insert. Inserts have a chrome finish. Matching key is zinc die-cast.

**BULLETIN: A4GY, CWY**

Catalog Number	Description
CLKTM7	Triangular 7-mm insert with key
CLKSM7	Square 7-mm insert with key
CLKDBM3	Double bit with key
CLKSLOT	Slotted Insert no key

**MOUNTING BRACKET KITS**



Mounting-Bracket Kits are field installable. Composite and stainless steel brackets are rated to Type 4X. Set of four (4) brackets can support 500 lb. (227 kg) maximum load. All hardware is included. Four brackets per kit.

*Mounting brackets are required to maintain UL/CSA external mounting requirement.*

**BULLETIN: A80**

Catalog Number	Description	Fastener Thread Size
CMFK	Steel	#3/8-16
CMFKSS	Stainless Steel	#3/8-16
CMTGFT	Composite	#3/8-16

**DATA POCKETS**



Provides a convenient place to store wiring diagrams, operation manuals and other documentation inside the enclosure. Adhesive-backed pockets mount inside the solid enclosure cover. Mounting hardware included. Thermoplastic pockets are dark gray and have cut-away areas for easy inspection of contents.

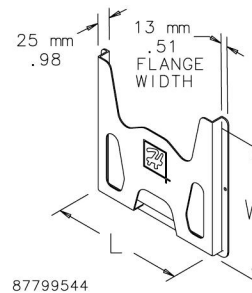

Catalog Number	Description	L in./mm	W in./mm
ADP1	Small pocket	6.00 152	6.00 152
ADP2	Large pocket	12.00 305	12.00 305

Use ADP2 when A = 24 and B = 30

**VELCRO® CABLE WRAP**



Securely holds cable to cable manager and unfastens easily for cable maintenance. VELCRO® is 0.5-in. (12.7-mm) wide. Available in 8- and 12-in. (203- and 305-mm) lengths in both screw fastener and wrap styles. M5 self-tapping screw is used on Net Series or PROLINE frames.

VELCRO is a trademark of Velcro Industries B.V.

BULLETIN: DACCY

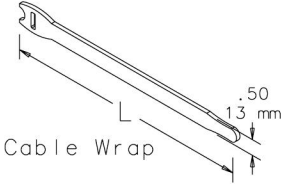
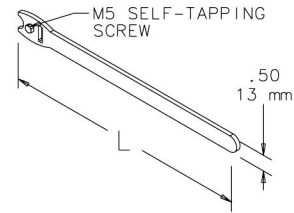

87951397

Catalog Number	Description	L (in.)	L (mm)	Color	Pkg. Qty.
ECWTD8B	Screw fastener style. Includes M5 mounting screw.	8.00	203	Black	10
ECWTD12B	Screw fastener style. Includes M5 mounting screw.	12.00	305	Black	10
ECW8B	Wrap style	8.00	203	Black	10
ECW8R	Wrap style	8.00	203	Red	10
ECW8BL	Wrap style	8.00	203	Blue	10
ECW8Y	Wrap style	8.00	203	Yellow	10
ECW12B	Wrap style	12.00	305	Black	10
ECW12R	Wrap style	12.00	305	Red	10
ECW12BL	Wrap style	12.00	305	Blue	10
ECW12Y	Wrap style	12.00	305	Yellow	10